

# SERVICE NOTES

## RADIO

SA6148T/00/01/02

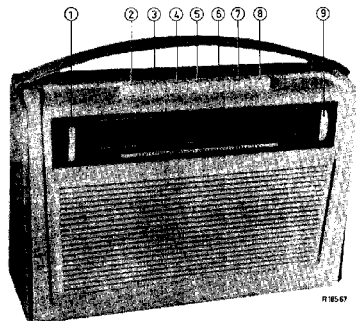

<u>Controls</u>	<u>Bediening</u>	<u>Bedienung</u>	<u>Comande</u>	<u>Organes de mando</u>
Volume control	1 Volumeregelaar	Lautstärkeregler	Contrôle de volume	1 Control de volumen
Switch for diallamp	2 Schaalverlichting	Schalter für Skala-lampe	Comm. d'éclairage	2 Comm. para alumbrado
Tone control	3 Toonregelaar	Klangregler	Contrôle de tonalité	3 Regulador de tono
L.W. switch	4 L.G.-schakelaar	L.W.-Schalter	Commutateur G.O.	4 Comm. de O.L.
M.W. switch	5 M.G.-schakelaar	M.W.-Schalter	Commutateur P.O.	5 Comm. de O.N.
S.W.1 Switch	6 K.G.1-schakelaar	K.W.1-Schalter	Commutateur O.C.1	6 Comm. de O.C.1
S.W.2 Switch	7 K.G.2-schakelaar	K.W.2-Schalter	Commutateur O.C.2	7 Comm. de O.C.2
Battery switch	8 Batterijschakelaar	Batterieschalter	Comm. de batterie	8 Comm. para pila
Tuning	9 Afstemming	Abstimmung	Syntonisation	9 Sintonía

<u>Specification</u>	<u>Specificatie</u>	<u>Spezifikation</u>	<u>Specification</u>	<u>Specificación</u>
Loudspeaker	AD 3500 HWZ	Luidspreker	Haut-parleur	AD 3500 HWZ
I.F.	452 kc/s	M.F.	Z.F.	452 kc/s
Battery voltage	9 V (6x1½ V)	Batterijspanning	Batteriespannung	Tens. de batterie 9 V (6x1½ V)
Consumption (without signal)	30 mA	Verbruik (zonder signaal)	Verbrauch (ohne Signal)	30 mA
Dimensions	311x212x101 mm 12½"x8½"x4"	Afmetingen	Abmessungen	311x212x101 mm 12½"x8½"x4"
				Tens. de pila Consuma (sin señal) Dimensiones

Wave ranges - Golfbereiken - Wellenbereiche - Gammes d'ondes - Margen de ondas

L.W.	- L.G.	- L.W.	- G.O.	- O.L.	: 750 - 2000 m ( 400 - 150 kc/s)
M.W.	- M.G.	- M.W.	- P.O.	- O.N.	: 185 - 580 m (1622 - 517 kc/s)
S.W.1	- K.G.1	- K.W.1	- O.C.1	- O.C.1	: 19,36 - 39,4 m (15,5 - 7,6 Mc/s)
S.W.2	- K.G.2	- K.W.2	- O.C.2	- O.C.2	: 39,4 - 83,3 m ( 7,6 - 3,6 Mc/s)

<u>Transistors - Transistoren - Transistoren - Transistors - Transistors</u>
OC170 (2N371) - OC45 - OC45 -
OA79 - OA85 - OC75 - OC75 - 2xOC74
LA: 7994 N

SERVICE INFORMATION									
---------------------	--	--	--	--	--	--	--	--	--

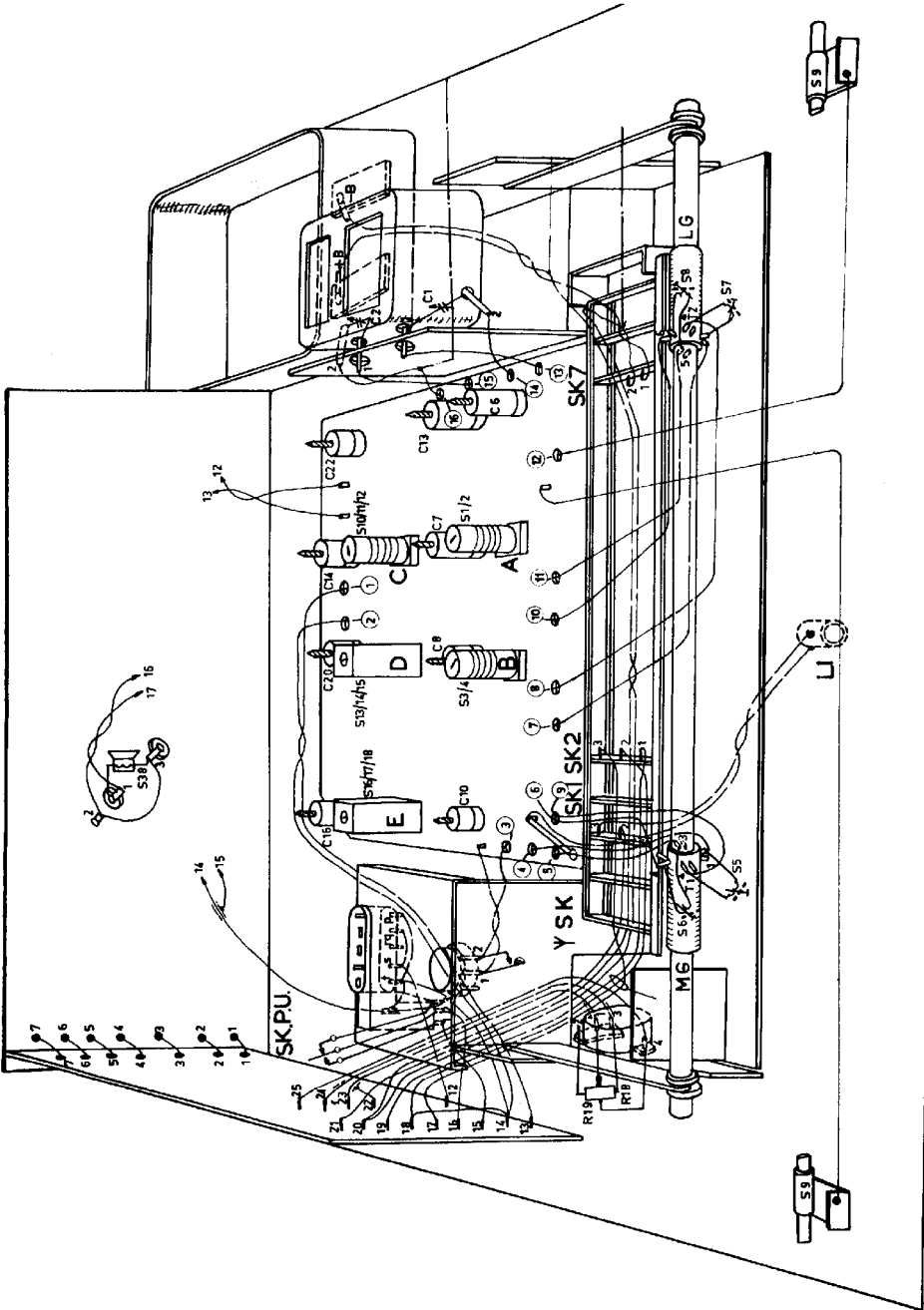

Serv.-o-Mecum E.-a.-1	Push button Druktoets Taste Touche pousseire Pulsador	Trimming point Trimpunt Trimpunkt Point de réglage Punto de ajuste	Signal Signaal Signal Signal Señal	Adjust to max. output Afstellen op max. uitgangsspanning Abgleichen auf max. Ausgangsspannung Régler au max. de sortie Ajustense al max. de salida
I.F.-M.F.-Z.F.-M.F.-F.I.	5	1	452 kc/s via 32000 pF b. ts. 3	S27-S26-S29, S30-S31
	5	1	452 kc/s via 32000 pF b. ts. 2	S22-S23-S24, S25-S26
	5	1	452 kc/s via 0,1 M. c. ts. 1	S19, S20-S21, C22
R.F. circuits H.F. kringen	5	2	550 kc/s	S13-S14-S15, S5
		1	1500 kc/s	C20, C8
H.F. Kreise	6	2	7,6 Mc/s	S1
		1	14,87 Mc/s	C14, C6
Circuits de H.F.	7	2	3,66 Mc/s	S10-S11-S12, S3
		1	7,3 Mc/s	C13, C7
Circuitos de R.F.	4	2	157 kc/s	S16-S17-S18, S7
		1	386 kc/s	C16, C10

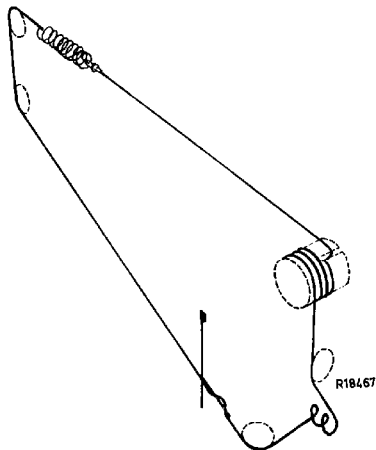
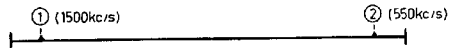

Cabinet 00	Kast 00	Sekäse 00	Coiffret 00	A3 009 75	Caja 00
Case C1	Kast C1	Cenäuse C1	Coiffret 01	A3 009 76	Caja 01
Case 02	Kast 02	Cenäuse 02	Coiffret 02	A3 009 61	Caja 02
Front	Front	Front	Front	P5 210 20/159/1X	Antena
Aerial	Antenne	Antenne	Antenne	A3 749 95	Antena
Battery holder	Batteriholder	Batteriehalter	Porte-pile	A3 788 15	Porta pila
Battery holder	Batteriholder	Batteriehalter	Porte-pile	A3 788 16	Porta pila
Handle	Handvat	Handgriff	Poignée	A3 358 78	Asa
Brommet for fix. varco	Tulle bev. varco	Tulle Bev. Varco	Canon fix. cond. var.	28 725 52	Manginito para fij. del cond. var.
Leg (4x)	Vestje (4x)	Fuss (4x)	Pied (4x)	P5 192 13/723/KE	Pie (4x)
Knob	Knoppen	Knöpfe	Boutons	A3 784 51	Botones
Contact slide	Contactenschuif	Kontaktschiebe	Contaisse de contacts	971/05	Placa portcontactos deslizante
Contact slide	Contactenschuif	Kontaktschiebe	Contaisse de contacts	971/02	Placa portcontactos deslizante
Contact spring	Contactveer	Kontaktfeder	Resort de contact	971/77	Resorte de contacto
Contact strip	Contactenstrip	Kontaktsreifen	Plaque fixe	971/101	Portcontactos fijo
Contact lip	Contactlip	Kontaktsaenge	Contact pour plaque fixe	971/75	Contacto fijo
Dial	Schaal	Scala	Calran	928/LX00T	Quadrante
Push button 2/7	Drüknop 2/7	Drucktaste 2/7	Touche poussoire 2/7	P5 420 22/159/FY	Pulsador 2/7
Push button 8	Drüknop 8	Drucktaste 8	Touche poussoire 8	A3 666 58	Pulsador 8
Female plug P.U.	Contraplug P.U.	Kontrastecker P.U.	Fiche femelle P.U.	A3 788 91	Clavija hembra fonosaptor

S1)	A3 985 64	S10)	A3 129 35	S27)	A3 134 32	C42	909/U320
S2)	A3 985 66	S11)	A3 129 35	S28)	C1)	C43	909/U320
S3)	A3 985 61	S12)	A3 129 34	S29)	C2)	C44	909/U320
S4)	A3 749 93	S13)	A3 129 34	S30)	C27	R18)	E 090 AG/00325
S5)	A3 749 93	S14)	A3 129 34	S31)	C36	R19)	E 090 AG/00325
S6)	A3 749 93	S15)	A3 129 34	S32)	C40	R42	B1 530 16
S7)	A3 749 93	S16)	A3 129 34	S33)	C41		JH/28
S8)	A3 749 93	S17)	A3 129 34	S34)			
S9)	A3 749 93	S18)	A3 129 34				

To order parts, which do not occur in this list consult the Catalogue for Service Spare Parts.

• men de Catalogus voor Service Standard Onderdelen.

• men de Catalogus voor Service Standard Onderdelen.

For the command des pièces qui ne figurent pas dans cette liste, veuillez consulter le Catalogue pour Pièces de Rechange Standard. Recambio Standard.

Für die Teile, welche nicht in der obigen Liste vorkommen, bitten wir Sie, sich an den Katalog für Ersatzteile zu wenden.

Para las piezas que no figuren en las listas de piezas consulto el Catalogo de Piezas de Reemplazo Standard.

5-9	2.4.6.8. 1.3.5.7.	10-18	19-28	29-38	39-48	49-58	59-68	69-78	79-88	89-98	99-108	109-118	119-128	129-138	139-148	149-158	159-168	169-178	179-188	189-198	199-208	209-218	219-228	229-238	239-248	249-258	259-268	269-278	279-288	289-298	299-308	309-318	319-328	329-338	339-348	349-358	359-368	369-378	379-388	389-398	399-408	409-418	419-428	429-438	439-448	449-458	459-468	469-478	479-488	489-498	499-508	509-518	519-528	529-538	539-548	549-558	559-568	569-578	579-588	589-598	599-608	609-618	619-628	629-638	639-648	649-658	659-668	669-678	679-688	689-698	699-708	709-718	719-728	729-738	739-748	749-758	759-768	769-778	779-788	789-798	799-808	809-818	819-828	829-838	839-848	849-858	859-868	869-878	879-888	889-898	899-908	909-918	919-928	929-938	939-948	949-958	959-968	969-978	979-988	989-998	999-1008
-----	-------------------	-------	-------	-------	-------	-------	-------	-------	-------	-------	--------	---------	---------	---------	---------	---------	---------	---------	---------	---------	---------	---------	---------	---------	---------	---------	---------	---------	---------	---------	---------	---------	---------	---------	---------	---------	---------	---------	---------	---------	---------	---------	---------	---------	---------	---------	---------	---------	---------	---------	---------	---------	---------	---------	---------	---------	---------	---------	---------	---------	---------	---------	---------	---------	---------	---------	---------	---------	---------	---------	---------	---------	---------	---------	---------	---------	---------	---------	---------	---------	---------	---------	---------	---------	---------	---------	---------	---------	---------	---------	---------	---------	---------	---------	---------	---------	---------	---------	---------	---------	----------

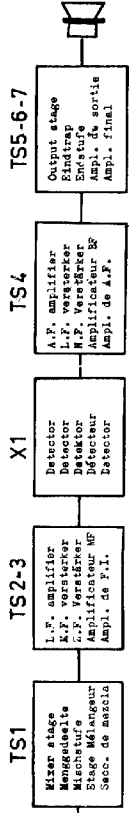
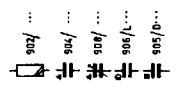
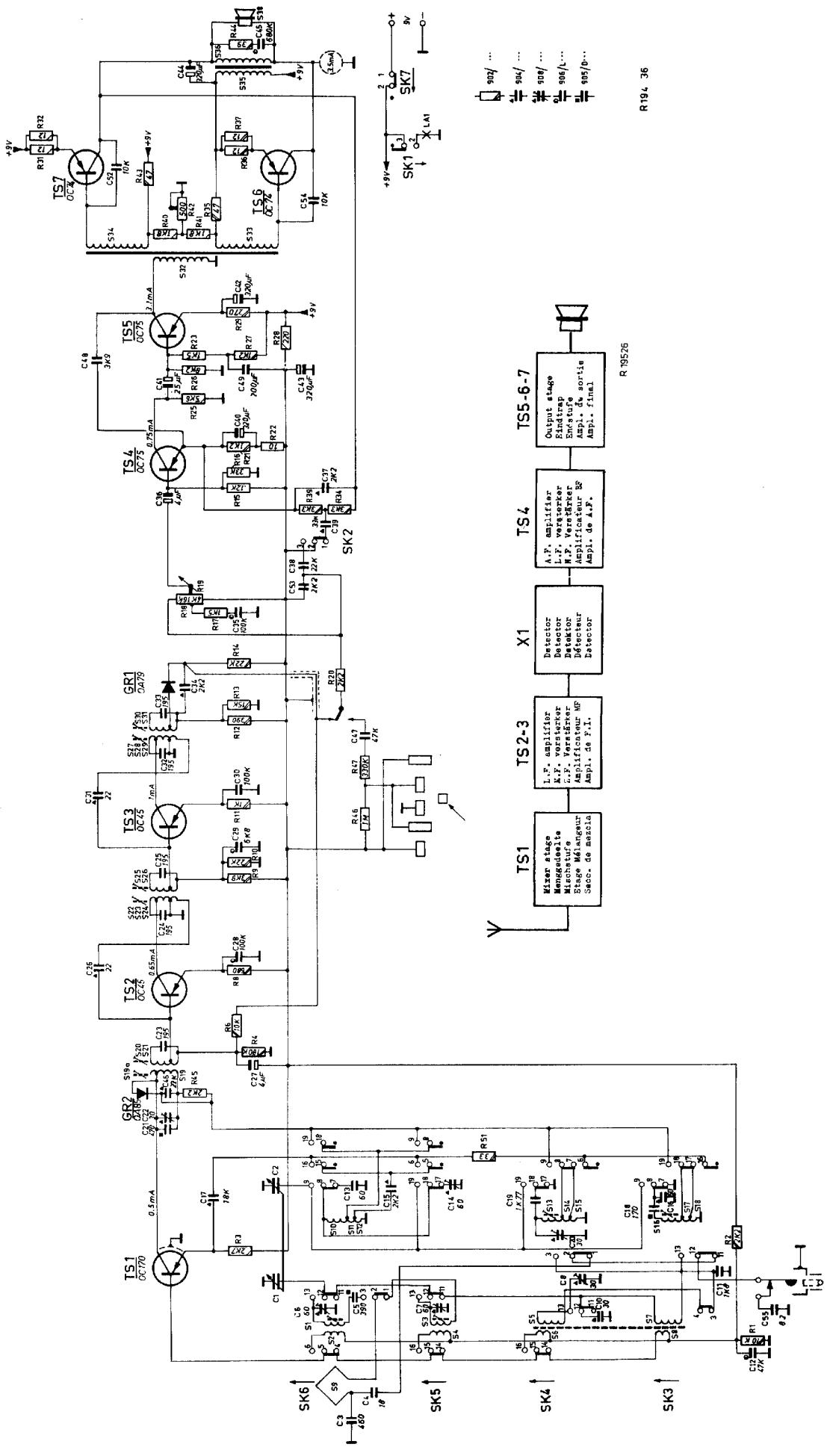

R 194 36

R 79526

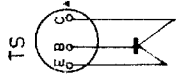
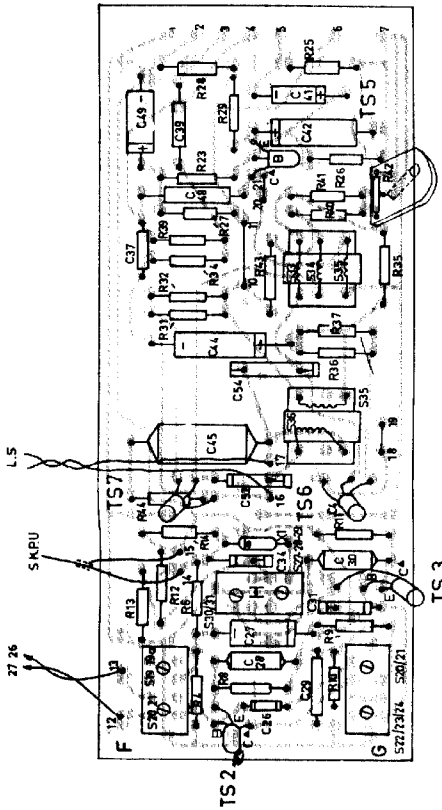

R194 54

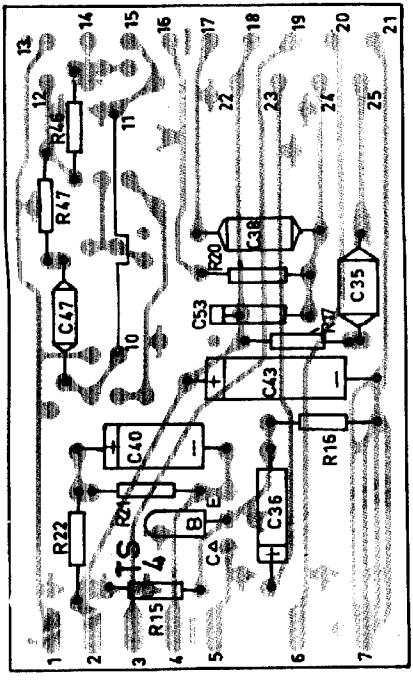
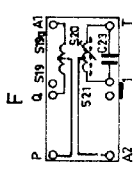
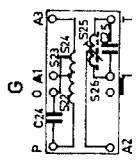
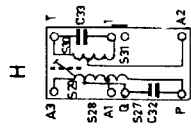

R194 55

S	E	B. D.	A. C.
C	55	10/19/16	11
R	1	51	2
	8	9	70
	4	12	5
	3	17	46
	6	22	113
			45

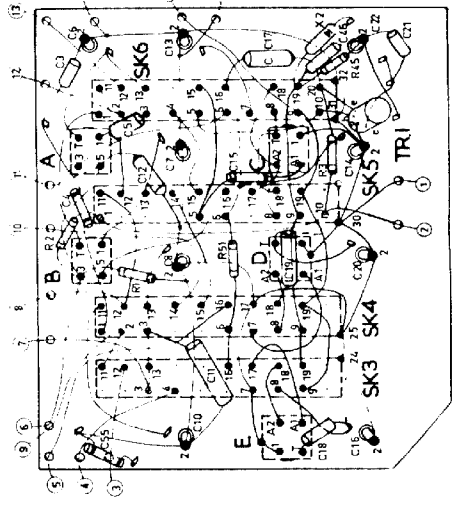

R194 37